

<b>18 - 36V</b> Continuous Input	<b>1.8V</b> Outputs	<b>25A</b> Current	<b>45W</b> Max Power	<b>2000V dc</b> Isolation	<b>Quarter-brick</b> DC-DC Converter
-------------------------------------	------------------------	-----------------------	-------------------------	------------------------------	-----------------------------------------

The PQ24018QGx25 PowerQor® Giga quarter-brick converter is a next-generation, board-mountable, isolated, fixed switching frequency DC-DC converter that uses synchronous rectification to achieve extremely high conversion efficiency. The power dissipated by the converter is so low that a heatsink is not required, which saves cost, weight, height, and application effort. All of the power and control components are mounted to the multi-layer PCB substrate with high-yield surface mount technology. Since the PowerQor converter has no explicit thermal connections, it is extremely reliable. RoHS Compliant, see last page.

## PowerQor®

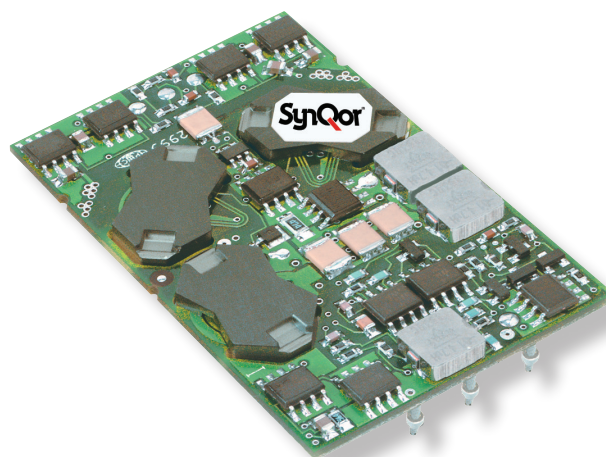

PQ24018QGx25 Module

### Operational Features

- High efficiency, >84% at full rated load current
- Delivers up to 25 amps of output current with minimal derating - no heatsink required
- Wide input voltage range: 18V - 36V meets or exceeds all 24V bus standards
- Fixed frequency switching provides predictable EMI performance
- No minimum load requirement means no preload resistors required.

### Mechanical Features

- Industry standard pin-out configuration
- Standard Size Open Frame: 1.45" x 2.30" (36.8 x 58.4mm)
- Open Frame height: .40" (10.2mm),
- Open Frame Weight: 1.2 oz. (34g)
- Flanged pins designed to permit surface mount soldering (avoid wave solder) using FPIP technique on Open Frame Units

### Control Features

- On/Off control referenced to input side (positive and negative logic options are available)
- Remote sense for the output voltage compensates for output distribution drops
- Output voltage trim permits custom voltages and voltage margining

### Protection Features

- Input under-voltage lockout disables converter at low input voltage conditions
- Output current limit and short circuit protection protects converter from excessive load current or short circuits
- Output over-voltage protection protects load from damaging voltages
- Thermal shutdown protects converter from abnormal

### Safety Features

- CAN/CSA C22.2 No. 60950-1
- UL 60950-1
- EN 60950-1

### Contents

	Page No.
Mechanical Diagrams . . . . .	2
Electrical Characteristics . . . . .	4
Figures . . . . .	6
Application Section . . . . .	10
Ordering Information . . . . .	16

**Input: 18 - 36V**  
**Output: 1.8V**  
**Current: 25A**  
**Package: Quarter-brick**

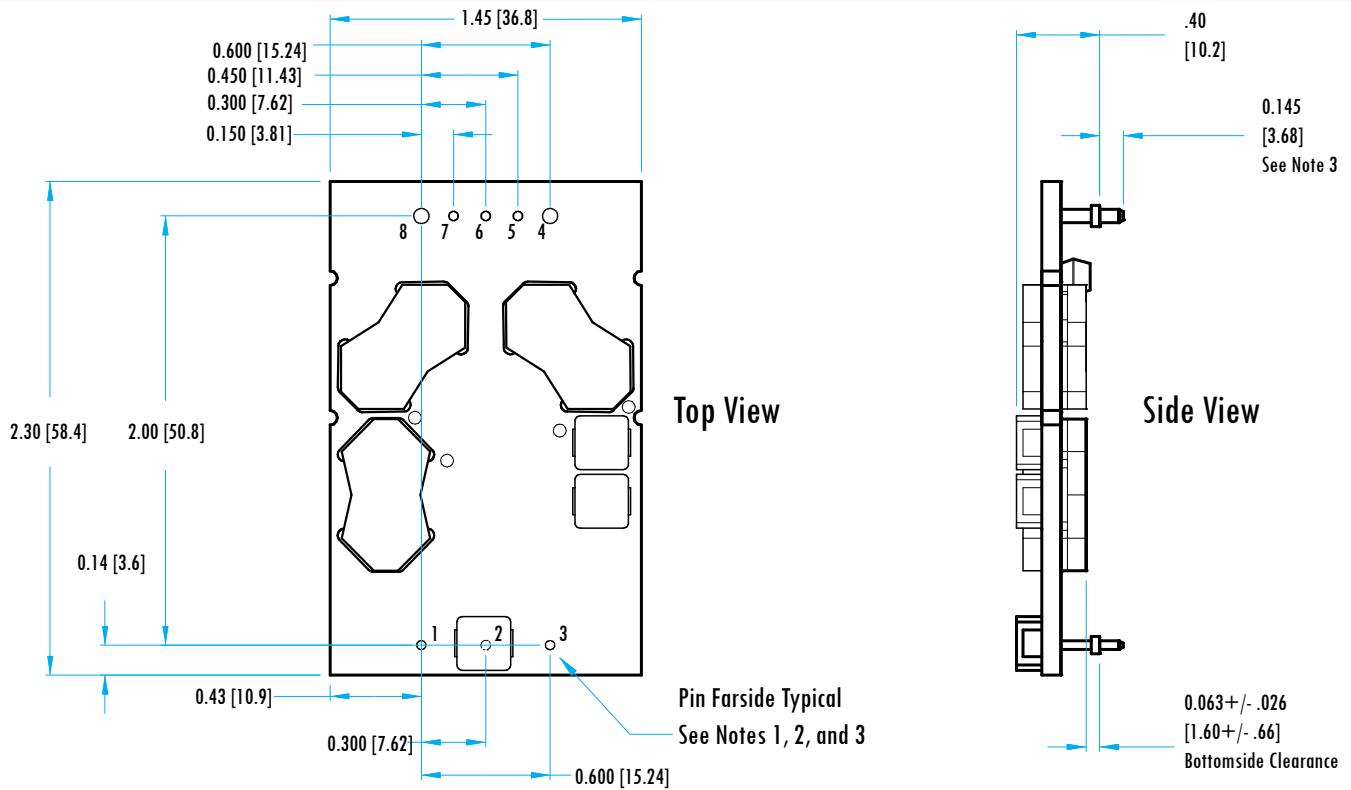

### NOTES

- 1) Pins 1-3, 5-7 are 0.040" (1.02mm) diameter with 0.080" (2.03mm) diameter standoff shoulders
- 2) Pins 4 and 8 are 0.0620" (1.57mm) diameter with 0.100" (2.54mm) diameter standoff shoulders
- 3) All Pins: Material - Copper Alloy  
 Finish: Matte Tin over Nickel Plate
- 4) Other pin extension lengths available.
- 5) Undimensioned components are shown for visual reference only.
- 6) Open Frame Weight: 1.2 oz. (34g)
- 7) All dimensions in inches (mm) Unless otherwise specified:  
 Tolerances X.XXin. +/-0.02 (X.Xmm +/-0.5mm)  
 X.XXin. +/-0.010 (X.XXmm +/-0.25mm)
- 8) Workmanship: Meets or exceeds IPC-A-610 Class II

### PIN DESIGNATIONS

Pin	Name	Function
1	Vin(+)	Positive input voltage
2	ON/OFF	TTL input to turn converter on and off, referenced to Vin(-), with internal pull up.
3	Vin(-)	Negative input voltage
4	Vout(-)	Negative output voltage
5	SENSE(-)	Negative remote sense (See note 1)
6	TRIM	Output voltage trim (See note 2)
7	SENSE(+)	Positive remote sense (See note 3)
8	Vout(+)	Positive output voltage

#### Notes:

- 1) SENSE(-) should be connected to Vout(-) either remotely or at the converter.
- 2) Leave TRIM pin open for nominal output voltage.
- 3) SENSE(+) should be connected to Vout(+) either remotely or at the converter.

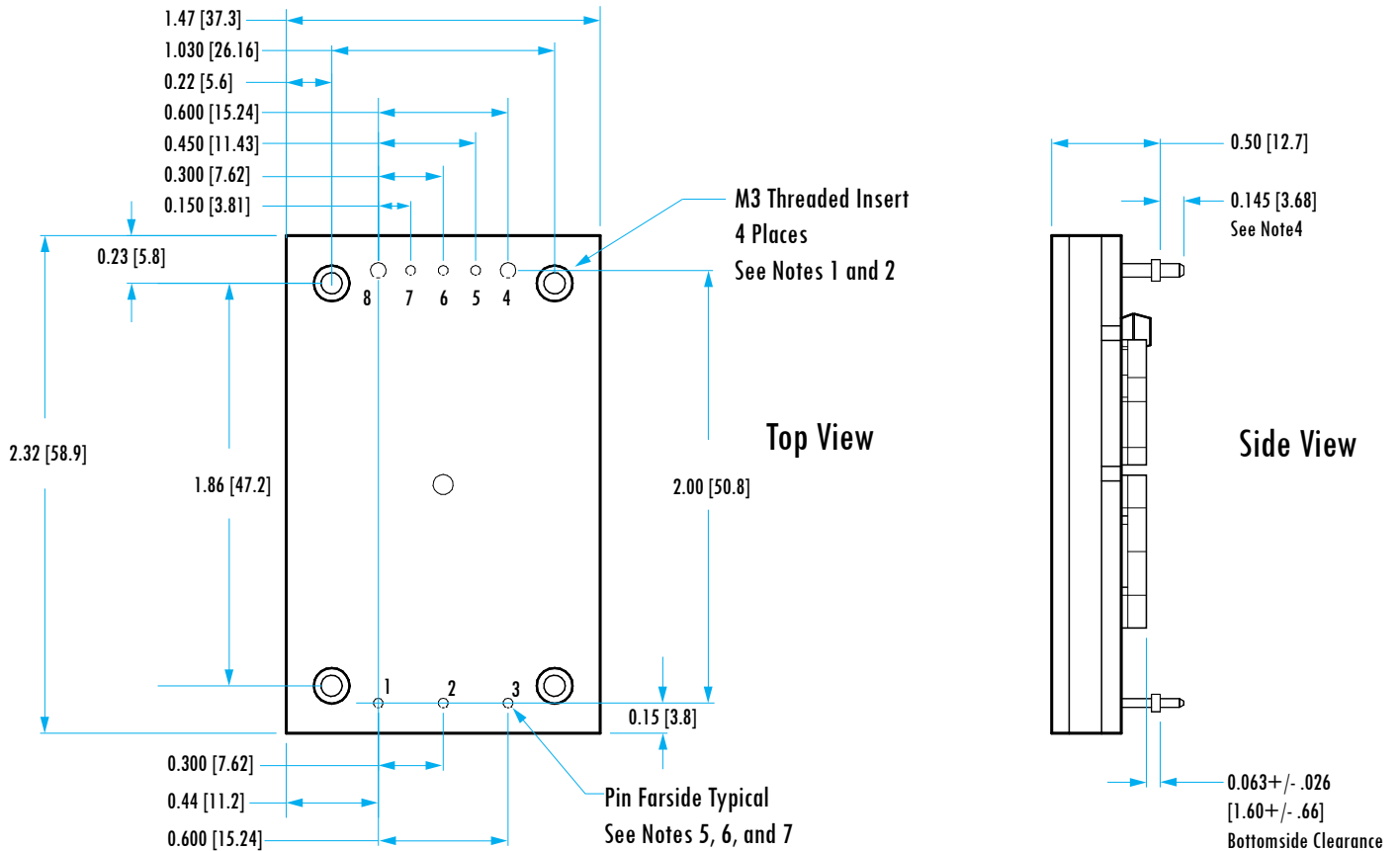

### NOTES

- 1) M3 Screws used to bolt unit's Baseplate to other surfaces (such as heatsink) Must not exceed 0.138" (3.50mm) depth below the surface of the Baseplate
- 2) Applied Torque should not exceed 6in-lb (0.7Nm)
- 3) Baseplate flatness tolerance is 0.004" (.10mm) TIR for surface
- 4) Other pin extension lengths available.
- 5) Pins 1-3, 5-7 are 0.040" (1.02mm) Dia. with 0.080" (2.03mm) Dia. Standoff shoulders
- 6) Pins 4, 8 are 0.062" (1.57mm) Dia. with 0.100" (2.54mm) Dia. Standoff shoulders
- 7) All Pins: Material - Copper Alloy  
Finish: Matte Tin over Nickel Plate
- 8) Undimensioned components are shown for visual reference only. All dimensions in inches (mm)
- 9) Baseplate Weight: 2.1 oz. (61g) typical
- 10) All dimensions in inches (mm)  
Unless otherwise specified:  
Tolerances X.XXin. +/-0.02 (X.Xmm +/-0.5mm)  
X.XXin. +/-0.010 (X.XXmm +/-0.25mm)
- 11) Workmanship: Meets or exceeds IPC-A-610 Class II

### PIN DESIGNATIONS

Pin	Name	Function
1	Vin(+)	Positive input voltage
2	ON/OFF	TTL input to turn converter on and off, referenced to Vin(-), with internal pull up.
3	Vin(-)	Negative input voltage
4	Vout(-)	Negative output voltage
5	SENSE(-)	Negative remote sense (See note 1)
6	TRIM	Output voltage trim (See note 2)
7	SENSE(+)	Positive remote sense (See note 3)
8	Vout(+)	Positive output voltage

#### Notes:

- 1) SENSE(-) should be connected to Vout(-) either remotely or at the converter.
- 2) Leave TRIM pin open for nominal output voltage.
- 3) SENSE(+) should be connected to Vout(+) either remotely or at the converter.

## PQ24018QGx25 Electrical Characteristics

Ta = 25 °C, airflow rate = 300 LFM, Vin = 24Vdc, nominal Vout unless otherwise noted; full operating temperature range is -40 °C to +115 °C ambient temperature with appropriate power derating. Specifications subject to change without notice.

Parameter	Min.	Typ.	Max.	Units	Notes & Conditions
<b>INPUT CHARACTERISTICS</b>					
Operating Input Voltage Range	18	24	36	V	
Input Under-Voltage Lockout					
Turn-On Voltage Threshold	15.5	16	16.5	V	
Turn-Off Voltage Threshold	14	14.5	15	V	
Lockout Hysteresis Voltage	1.0	1.5	2.0	V	
Maximum Input Current			3.0	A	100% Load, 18Vin
No-Load Input Current		60	100	mA	
Off Converter Input Current		1.6	3	mA	
Input Reflected-Ripple Current		6		mA	P-P thru 3.3µH inductor; Figures 13 & 15
<b>OUTPUT CHARACTERISTICS</b>					
Output Voltage Set Point	1.782	1.800	1.816	V	
Output Voltage Regulation					
Over Line		+0.1 (2)	+0.3 (5)	% (mV)	
Over Load		+0.1 (2)	+0.3 (5)	% (mV)	
Over Temperature		±9	±27	mV	
Total Output Voltage Range	1.75		1.85	V	Over sample line, load and temperature
Output Voltage Ripple and Noise					20MHz bandwidth; Figures 13 & 16
Peak-to-Peak		25	50	mV	Full Load, 1µF ceramic, 10µF tantalum
RMS		6	12	mV	Full Load, 1µF ceramic, 10µF tantalum
Operating Output Current Range	0		25	A	
Output DC Current-Limit Inception	26	30	34	A	Output Voltage 10% Low; Fig 17 & 18
Short-Circuit Protection (redundant shutdown)	52	56	60	A	
<b>DYNAMIC CHARACTERISTICS</b>					
Input Voltage Ripple rejection		TBD		dB	120 Hz; Figure 20
Output Voltage Current Transient					470µF load cap, 5A/µs; Figure 12
Positive Step Change in Output Current		190		mV	50% lo to 75% lo
Negative Step Change in Output Current		190		mV	75% lo to 50% lo
Settling Time to within 1% Vout nominal		700		µs	
Turn-On Transient					
Turn-On Time	1	4	8	ms	Full load, Vout=90% nom.; Figs 9 & 10
Start-Up Inhibit Period	180	200	215	ms	-40°C to +125°C; Figure F
Maximum Output Capacitance			35,000	µF	Full load; 5% overshoot of Vout at startup
<b>EFFICIENCY</b>					
100% Load		84		%	Figure 1
50% Load		87		%	
<b>TEMPERATURE LIMITS FOR POWER DERATING CURVES</b>					
Semiconductor Junction Temperature			125	°C	Plastic Package rated to 150°C
Board Temperature			125	°C	Board rated to 165°C
Transformer Temperature			125	°C	Figures 5 - 8
<b>ISOLATION CHARACTERISTICS</b>					
Isolation Voltage	2000			V	
Isolation Resistance	10			MΩ	
Isolation Capacitance		470		pF	





# Technical Specifications

**Input:** 18 - 36V  
**Output:** 1.8V  
**Current:** 25A  
**Package:** Quarter-brick

## PQ24018QGx25 Electrical Characteristics (continued)

Ta = 25 °C, airflow rate = 300 LFM, Vin = 24V dc unless otherwise noted; full operating temperature range is -40 °C to +115 °C baseplate temperature with appropriate power derating. Specifications subject to change without notice.

Parameter	Min.	Typ.	Max.	Units	Notes & Conditions
<b>FEATURE CHARACTERISTICS</b>					
Switching Frequency	220	240	260	kHz	
ON/OFF Control (Option P)					
Off-Stage Voltage	-2		0.8	V	
On-Stage Voltage	2.4		18	V	
ON/OFF Control (Option N)					
Off-Stage Voltage	2.4		18	V	
On-Stage Voltage	-2		0.8	V	
ON/OFF Control (Either Option)					
Pull-up Voltage		Vin/3	9.6	V	See circuit diagram; Figure B
Pull-up Resistance		33		kΩ	Pull up to Vin/3
Output Voltage Trim Range	-20		+10	%	Across Pins 8 & 4; % of nominal Vout
Output Over-Voltage Protection	117	122	127	%	Over full temp range; % of nominal Vout
Over-Temperature Shutdown		125		°C	Average PCB Temperature

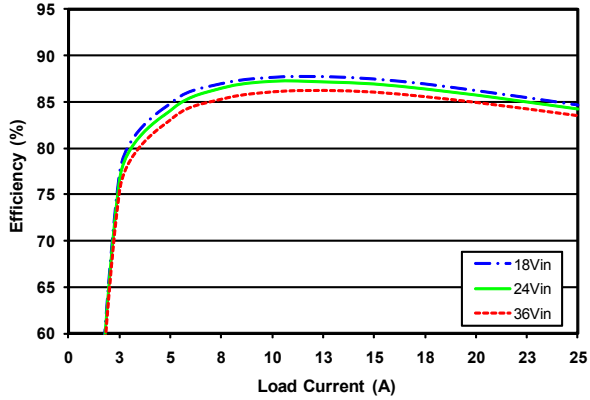

Figure 1: Efficiency at nominal output voltage vs. load current for minimum, nominal, and maximum input voltage at 25°C.

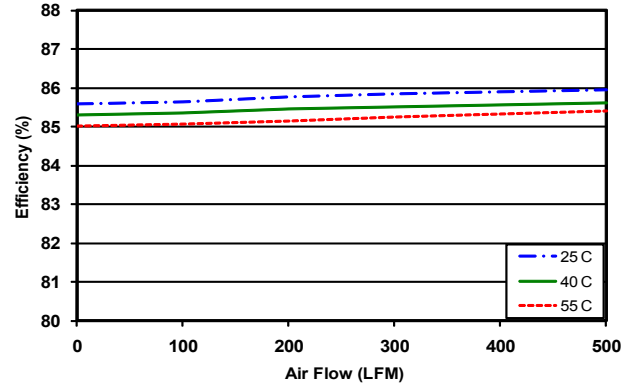

Figure 2: Efficiency at nominal output voltage and 60% rated power vs. airflow rate for ambient air temperatures of 25°C, 40°C, and 55°C (nominal input voltage).

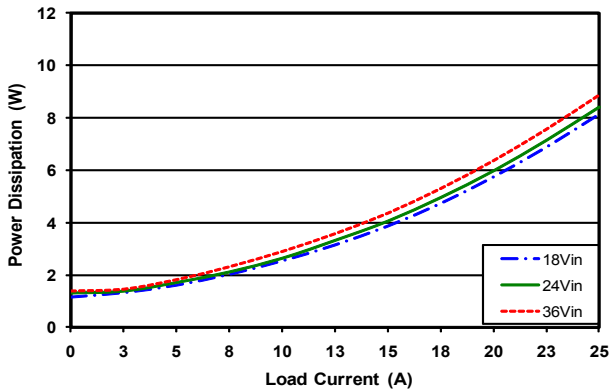

Figure 3: Power dissipation at nominal output voltage vs. load current for minimum, nominal, and maximum input voltage at 25°C.

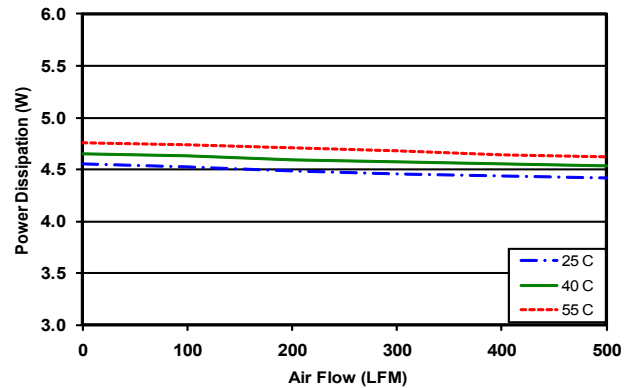

Figure 4: Power dissipation at nominal output voltage and 60% rated power vs. airflow rate for ambient air temperatures of 25°C, 40°C, and 55°C (nominal input voltage).

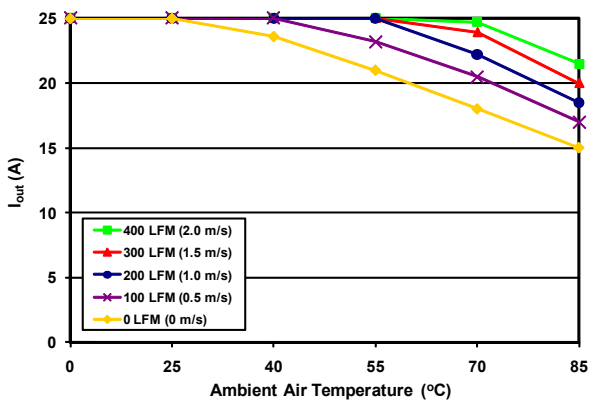

Figure 5: Maximum output power derating curves vs. ambient air temperature for airflow rates of 0 LFM through 400 LFM with air flowing across the converter from pin 1 to pin 3 (nominal input voltage)

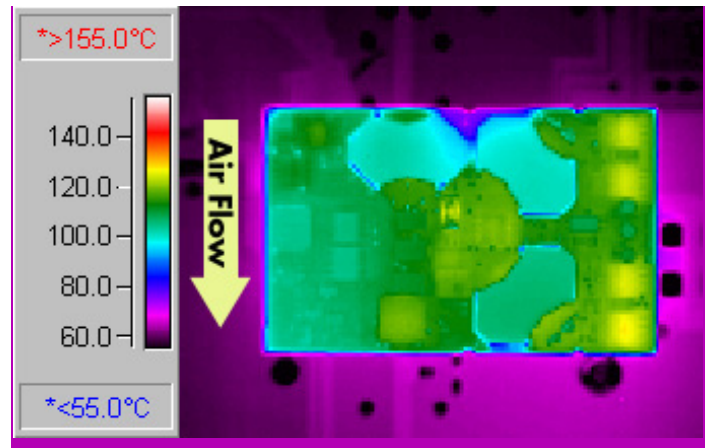

Figure 6: Thermal plot of converter at 25 amp load current with 55°C air flowing at the rate of 200 LFM. Air is flowing across the converter sideways from pin 1 to pin 3 (nominal input voltage)

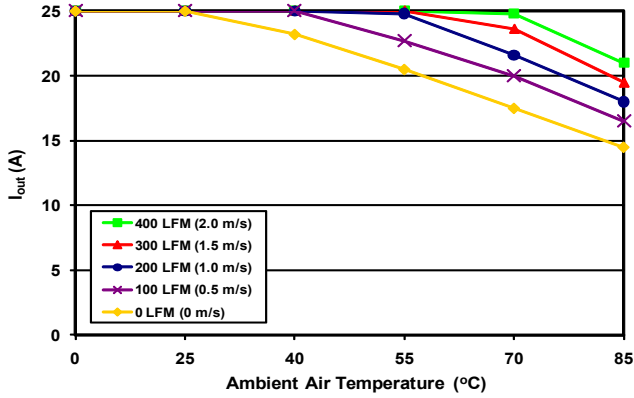

Figure 7: Maximum output power derating curves vs. ambient air temperature for airflow rates of 0 LFM through 400 LFM with air flowing lengthwise from output to input (nominal input voltage).

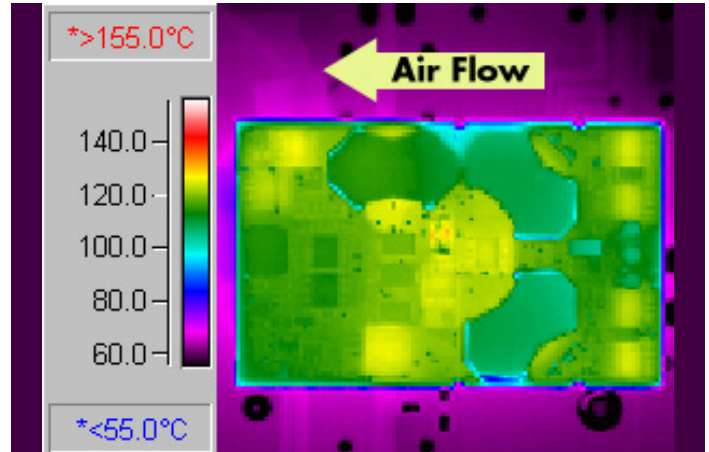

Figure 8: Thermal plot of converter at 25 amp load current with 55°C air flowing at the rate of 200 LFM. Air is flowing across the converter from output to input (nominal input voltage).

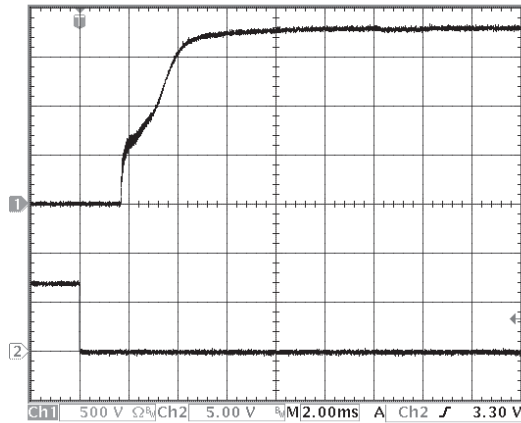

Figure 9: Turn-on transient at full load (resistive load) (2 ms/div). Ch 1:  $V_{out}$  (500mV/div) Ch 2: ON/OFF input (5V/div)

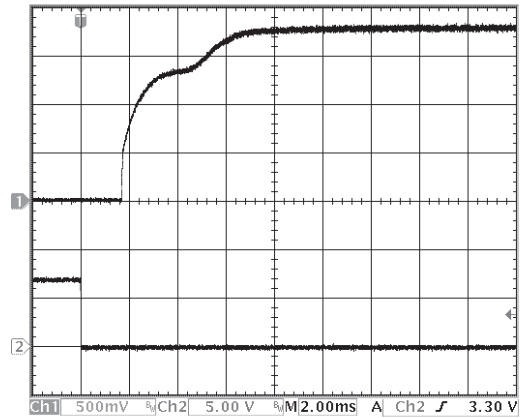

Figure 10: Turn-on transient at zero load (2 ms/div). Ch 1:  $V_{out}$  (500mV/div). Ch 2: ON/OFF input (5V/div).

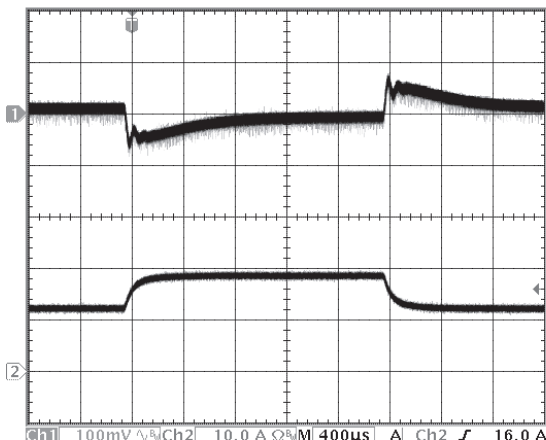

Figure 11: Output voltage response to step-change in load current (50%-75%-50% of  $I_{out(max)}$ ;  $dI/dt = 0.1A/\mu s$ ). Load cap: 10µF, 100 mΩ ESR tantalum cap and 1µF ceramic cap. Ch 1:  $V_{out}$  (100mV/div), Ch 2:  $I_{out}$  (10A/div).

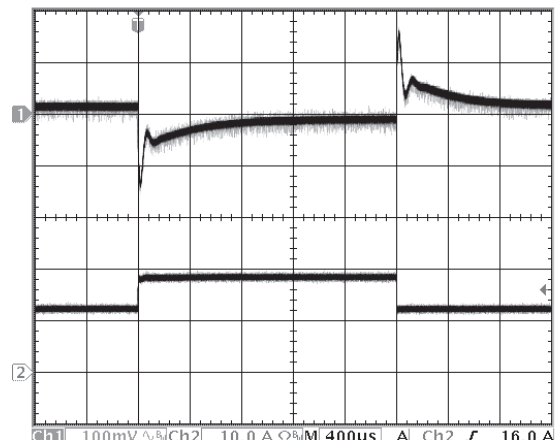

Figure 12: Output voltage response to step-change in load current (50%-75%-50% of  $I_{out(max)}$ ;  $dI/dt = 5A/\mu s$ ). Load cap: 470µF, 30 mΩ ESR tantalum cap and 1µF ceramic cap. Ch 1:  $V_{out}$  (100mV/div), Ch 2:  $I_{out}$  (10A/div).

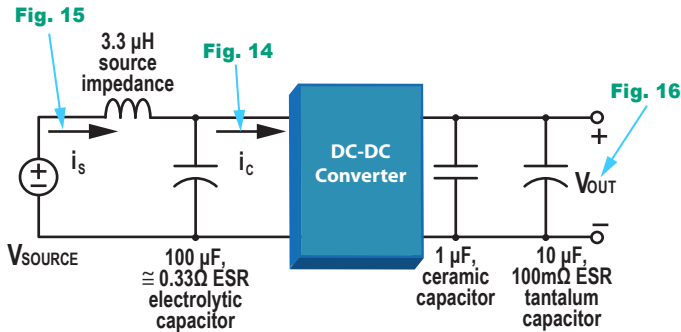

Figure 13: Test set-up diagram showing measurement points for Input Terminal Ripple Current (Figure 14), Input Reflected Ripple Current (Figure 15) and Output Voltage Ripple (Figure 16).

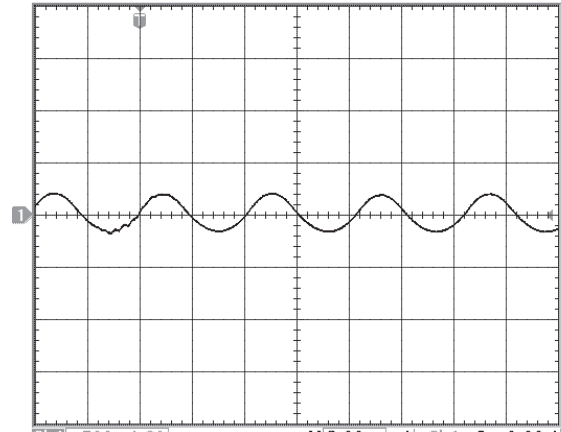

Figure 14: Input Terminal Ripple Current,  $i_c$ , at full rated output current and nominal input voltage with  $3.3 \mu\text{H}$  source impedance and  $100 \mu\text{F}$  electrolytic capacitor (500 mA/div). See Figure 13

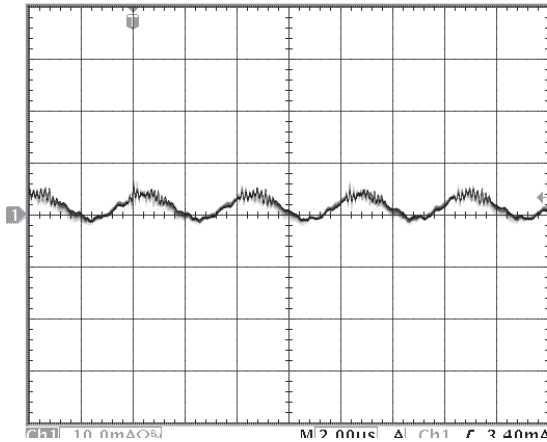

Figure 15: Input reflected ripple current,  $i_s$ , through a  $3.3 \mu\text{H}$  source inductor at nominal input voltage and rated load current (10 mA/div). See Figure 13

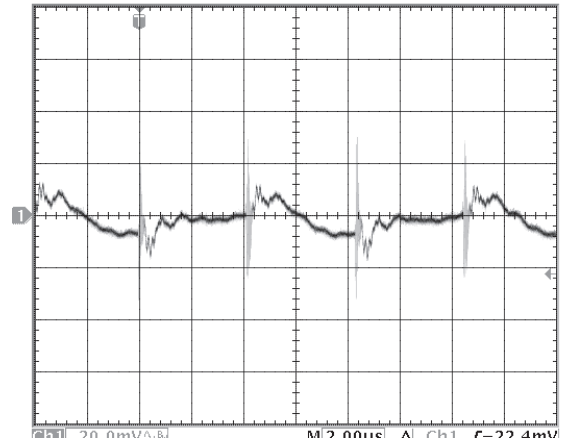

Figure 16: Output voltage ripple at nominal input voltage and rated load current (20 mV/div). Load capacitance:  $1 \mu\text{F}$  ceramic capacitor and  $10 \mu\text{F}$  tantalum capacitor. Bandwidth: 20 MHz. (See Figure 13)

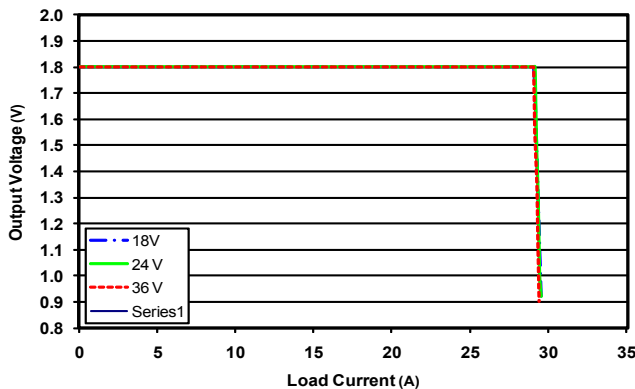

Figure 17: Output voltage vs. load current showing typical current limit curves. Below 0.9V (typical), the converter will shut off, and restart after a start-up inhibit period has elapsed. (see Figure F)

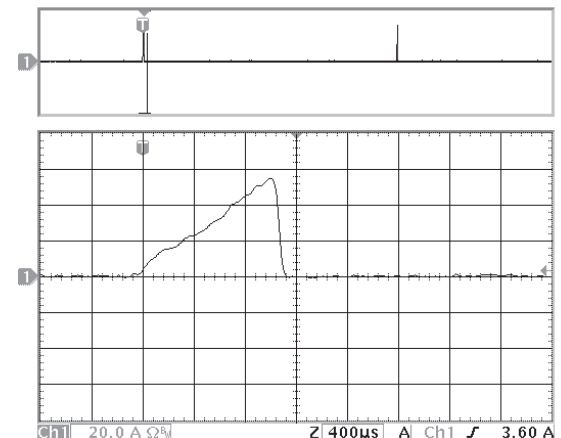

Figure 18: Load current (20A/div) as a function of time when the converter attempts to turn on into a  $10 \text{ m}\Omega$  short circuit. Top trace (2.5ms/div) is an expansion of the on-time portion of the bottom trace.



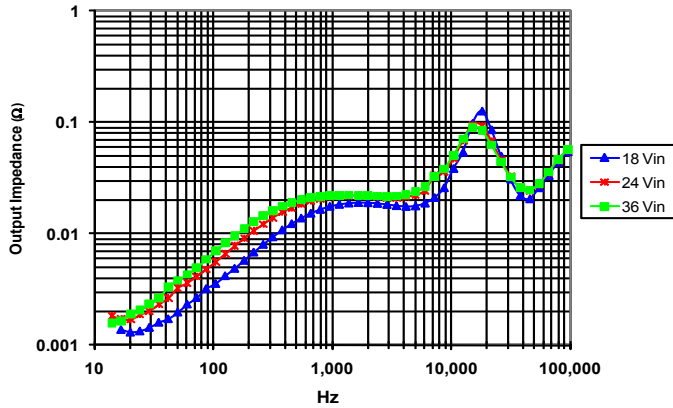

Figure 19: Magnitude of incremental output impedance ( $Z_{out} = v_{out}/i_{out}$ ) for minimum, nominal, and maximum input voltage at full rated power.

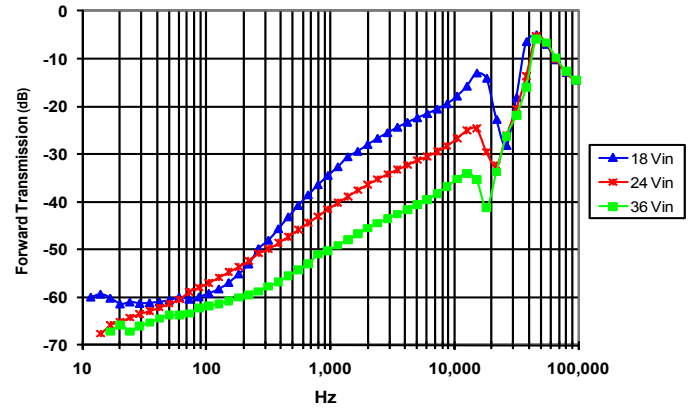

Figure 20: Magnitude of incremental forward transmission ( $FT = v_{out}/v_{in}$ ) for minimum, nominal, and maximum input voltage at full rated power.

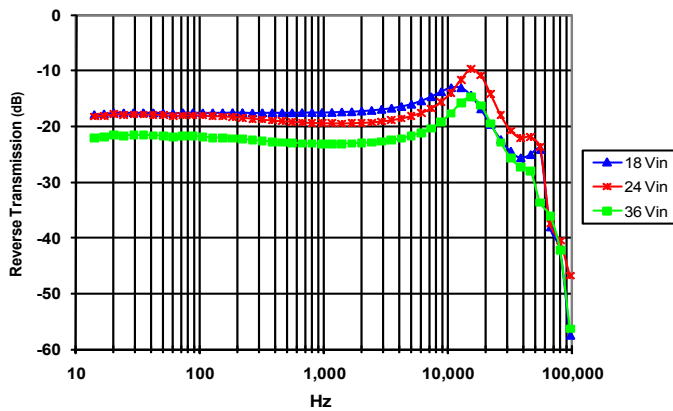

Figure 21: Magnitude of incremental reverse transmission ( $RT = i_{in}/i_{out}$ ) for minimum, nominal, and maximum input voltage at full rated power.

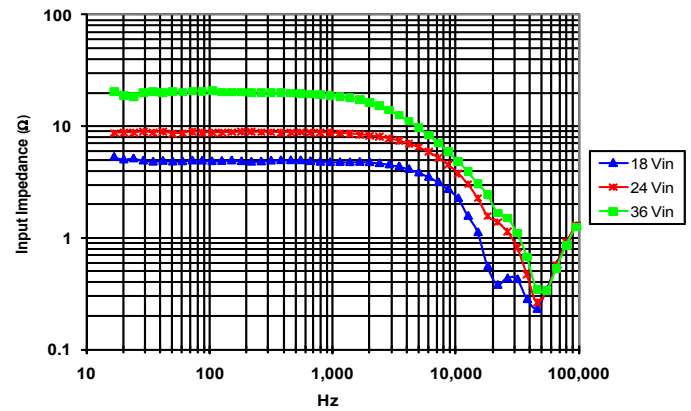

Figure 22: Magnitude of incremental input impedance ( $Z_{in} = v_{in}/i_{in}$ ) for minimum, nominal, and maximum input voltage at full rated power.

## BASIC OPERATION AND FEATURES

The *PowerQor* series converter uses a two-stage power circuit topology. The first stage is a buck-converter that keeps the output voltage constant over variations in line, load, and temperature. The second stage uses a transformer to provide the functions of input/output isolation and voltage step-down to achieve the low output voltage required.

Both the first stage and the second stage switch at a fixed frequency for predictable EMI performance. Rectification of the transformer's output is accomplished with synchronous rectifiers. These devices, which are MOSFETs with a very low on-state resistance, dissipate far less energy than Schottky diodes used in conventional dc/dc converters. This is the primary reason that the *PowerQor* converter has such high efficiency—even at very low output voltages and very high output currents.

Dissipation throughout the converter is so low that the **PowerQor converter requires no heatsink** to deliver a greater level of power than can be delivered by a conventional, Schottky-diode-based dc/dc converter with a 0.5" high heatsink. At equivalent ambient air temperature, airflow rate, and output power level, the hottest semiconductor junction temperature and the hottest PCB temperature within the *PowerQor* converter are cooler than those found in conventional dc/dc converters with a 0.5" high heatsink attached.

Since a heatsink is not required, the *PowerQor* converter does not need a metal baseplate or potting material to help conduct the dissipated energy to the heatsink. The *PowerQor* converter can thus be built more simply using high yield surface mount techniques on a PCB substrate.

Unlike conventional dc/dc converters, which have critical thermal connections between the power components and the baseplate, and between the baseplate and the heatsink, the *PowerQor* converter has no explicit, failure-prone thermal connections.

Compared to a conventional Schottky-diode-based dc/dc converter with a 0.5" high heatsink, the *PowerQor* converter is more efficient and therefore it dissipates less than half the energy. Additionally, because the *PowerQor* converter is thinner (0.4" vs. 1.0"), the board-to-board pitch in a rack can be much smaller, and cooling airflow is less impeded by

the converter. Because the *PowerQor* converter is much lighter, vibration and shock-induced problems are greatly reduced. Moreover, due to the lack of failure-prone explicit thermal connections and the lack of potting material the *PowerQor* converter is more reliable than conventional dc/dc converters.

The *PowerQor* series converter uses the industry standard pin-out configuration used by other vendors of comparably sized and rated dc/dc converters. The unit is pin for pin compatible with the Lucent QW series.

The *PowerQor* converter has many standard control and protection features. All shutdown features are non-latching, meaning that the converter shuts off for 200ms before restarting. (see *Figure F*)

- An **ON/OFF** input permits the user to control when the converter is *on* and *off* in order to properly sequence different power supplies and to reduce power consumption during a standby condition.
- **Remote sense** inputs permit the user to maintain an accurate voltage at the load despite distribution voltage drops between the converter's output and the load.
- An **output voltage trim** input permits the user to trim the output voltage up or down to achieve a custom voltage level or to do voltage margining.
- An **input under-voltage lockout** avoids input system instability problems while the input voltage is rising.
- The **output current limit** protects both the converter and the board on which it is mounted against a short circuit condition. (see *Figure 18*)
- An **output over-voltage limit** circuit shuts the unit down if the output voltage at the output pins gets too high.
- A sensor located in a central spot of the PCB provides a **PCB temperature limit**. If, due to an abnormal condition, this spot gets too hot, the converter will turn off. Once the converter has cooled, it will automatically turn on again without the need to recycle the input power.

## CONTROL PIN DESCRIPTIONS

**Pin 2 (ON/OFF):** The ON/OFF input, Pin 2, permits the user to control when the converter is *on* or *off*. This input is

referenced to the return terminal of the 24V input bus. There are two versions of the PowerQor series converter that differ by the sense of the logic used for the ON/OFF input. In the PQxyyyQGazzPxx version, the ON/OFF input is active high (meaning that a high turns the converter on). In the PQxyyyQGazzNxx version, the ON/OFF signal is active low (meaning that a low turns the converter on). Figure A details five possible circuits for driving the ON/OFF pin. Figure B shows detail of the internal ON/OFF circuitry.

**Pins 7 and 5 (SENSE(+)):** The SENSE(±) inputs correct for voltage drops along the conductors that connect the converter's output pins to the load.

Pin 7 should be connected to Vout(+) and Pin 5 should be connected to Vout(-) at the point on the board where regulation is desired. That is,

$$[V_{out(+)} - V_{out(-)}] - [SENSE(+)-SENSE(-)] \leq 10\%V_{out}$$

Pins 7 and 5 must be connected for proper regulation of the output voltage. However, if these connections are not made, nothing catastrophic will happen to the converter under normal operating conditions—the converter will simply deliver an output voltage that is slightly higher than its specified value.

Note: the output over-voltage protection circuit senses the

voltage across the output (pins 8 and 4) to determine when it should trigger, not the voltage across the converter's sense pins (pins 7 and 5). Therefore, the resistive drop on the board should be small enough so that output OVP does not trigger, even during load transients.

**Pin 6 (TRIM):** The TRIM input permits the user to adjust the output voltage across the sense leads up or down. To lower the output voltage, the user should connect a resistor between Pin 6 and Pin 5, which is the SENSE(-) input. To raise the output voltage, the user should connect a resistor between Pin 6 and Pin 7, which is the SENSE(+) input.

A resistor connected between Pin 6 and Pin 5 will decrease the output voltage. For a desired decrease of Δ percent of the nominal output voltage, the value of this resistor should be

$$R_{trim-down} = \left( \frac{511}{\Delta\%} \right) - 10.22 \text{ (k}\Omega\text{)}$$

where

$$\Delta = \left( \frac{V_{NOM} - V_{DES}}{V_{NOM}} \right) \times 100\%$$

and

$V_{NOM}$  = Nominal Voltage

$V_{DES}$  = Desired Voltage

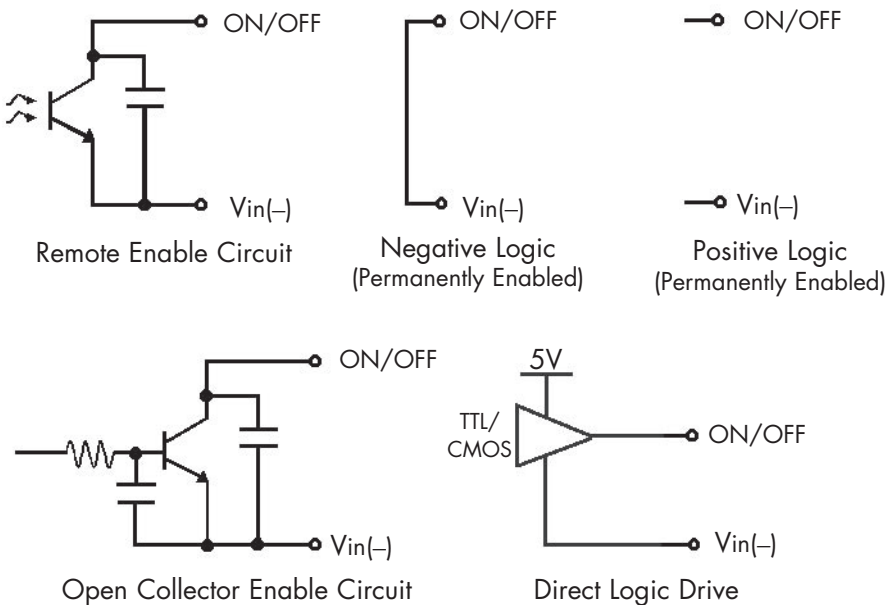

Figure A: Various circuits for driving the ON/OFF pin.

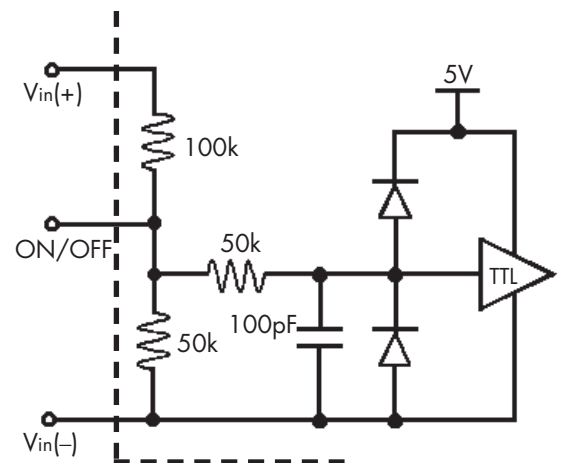
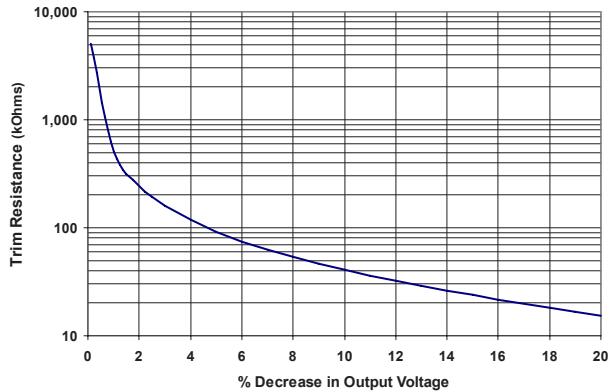

Figure B: Internal ON/OFF pin circuitry (detail)

Figure C graphs this relationship between  $R_{\text{trim-down}}$  and  $\Delta$ . The output voltage can be trimmed down as much as 20%.



**Figure C: Trim Down Graph for 1.8Vout**

A resistor connected between Pin 6 and Pin 7 will increase the output voltage. For a desired increase of  $\Delta$  percent of the nominal output voltage, the value of this resistor should be

$$R_{\text{trim-up}} = \left( \frac{5.11V_{\text{OUT}}(100+\Delta\%)}{1.225\Delta\%} - \frac{511}{\Delta\%} - 10.22 \right) (\text{k}\Omega)$$

where

$$V_{\text{OUT}} = \text{Nominal Output Voltage}$$

Figure D graphs this relationship between  $R_{\text{trim-up}}$  and  $\Delta$ . The output voltage can be trimmed up as much as 10%.

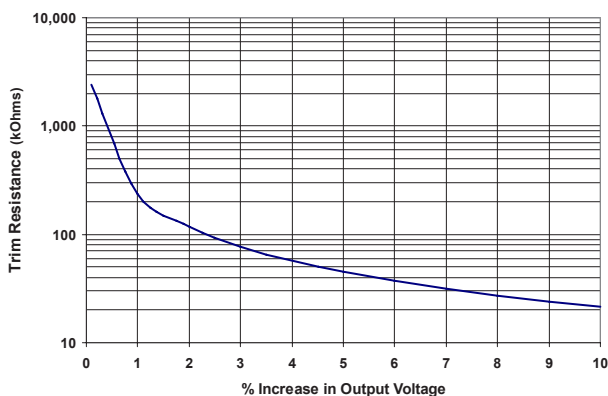

**Figure D: Trim Up Graph for 1.8Vout**

**Note:** The TRIM feature does not affect the voltage at which the output over-voltage protection circuit is triggered. Trimming the output voltage too high may cause the over-voltage protection circuit to trip, particularly during transients.

**TOTAL DC VARIATION OF  $V_{\text{out}}$ :** For the converter to meet its full specifications, the maximum variation of the dc value of  $V_{\text{out}}$ , due to both trimming and remote load voltage drops, should not be greater than +10%/-20%

## PROTECTION FEATURES

**Input Under-Voltage Lockout:** The converter is designed to turn off when the input voltage is too low, helping avoid an input system instability problem, described in more detail below. The lockout circuitry is a comparator with dc hysteresis. When the input voltage is rising, it must exceed a typical value of 16V before the converter will turn on. Once the converter is on, the input voltage must fall below a typical value of 14.5V before the converter will turn off.

**Output Current Limit:** The current limit does not change appreciably as the output voltage drops. However, once the impedance of the short across the output is small enough to make the output voltage drop below approximately 60% of its nominal value, the converter turns off.

The converter then enters a mode where it repeatedly turns on and off at a 5 Hz (nominal) frequency with a 5% duty cycle until the short circuit condition is removed. This prevents excessive heating of the converter or the load board.

**Output Over-Voltage Limit:** If the voltage across the output pins exceeds the O.V. threshold, the converter will immediately stop switching. This prevents damage to the load circuit due to 1) a sudden unloading of the converter, 2) a release of a short-circuit condition, or 3) a release of a current limit condition. Load capacitance determines exactly how high the output voltage will rise in response to these conditions. After 200 ms the converter will automatically restart.

**Thermal Shutdown:** The PowerQor series has a temperature sensor located such that it senses the average temperature of the converter. The thermal shutdown circuit is designed to turn the converter off when the temperature at the sensed location reaches 125°C. It will allow the con-



verter to turn on again when the temperature of the sensed location falls below 115°C.

## APPLICATION CONSIDERATIONS

**Input System Instability:** This condition can occur because a dc/dc converter appears incrementally as a negative resistance load. A detailed application note titled "Input System Instability" is available on the SynQor web site ([www.synqor.com](http://www.synqor.com)) which provides an understanding of why this instability arises, and shows the preferred solution for correcting it.

**Application Circuits:** Figure E below provides a typical circuit diagram which is useful when using input filtering and voltage trimming.

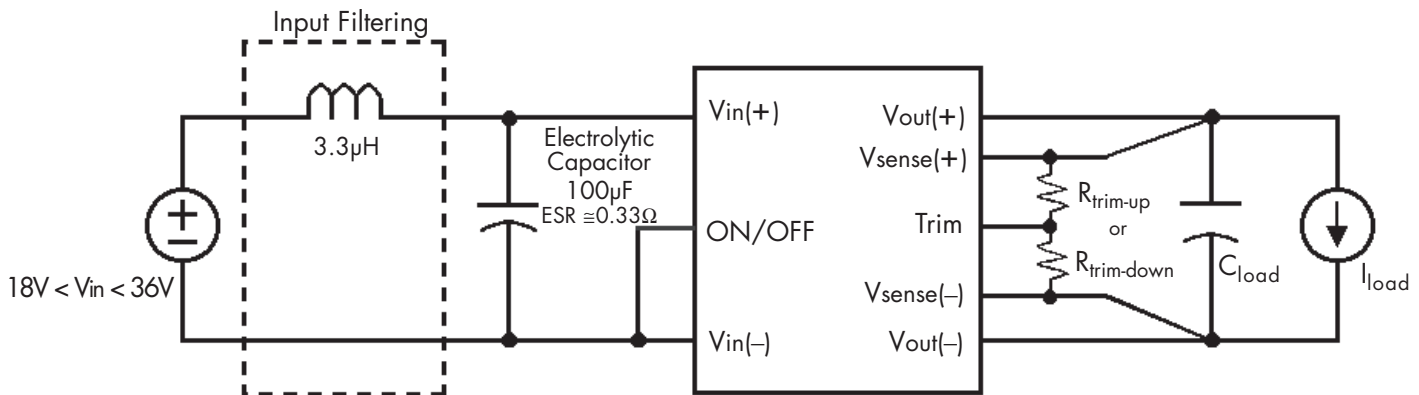

**Figure E:** Typical application circuit (negative logic unit, permanently enabled).

## STARTUP INHIBIT PERIOD

The Startup Inhibit Period ensures that the converter will remain off for at least 200ms when it is shut down for any reason. When an output short is present, this generates a 5Hz "hiccup mode," which prevents the converter from overheating. In all, there are seven ways that the converter can be shut down, initiating a Startup Inhibit Period:

- Input Under-Voltage Lockout
- Input Over-Voltage Shutdown (not present in Quarter-brick)
- Output Over-Voltage Protection
- Over Temperature Shutdown
- Current Limit
- Short Circuit Protection
- Turned off by the ON/OFF input

Figure F shows three turn-on scenarios, where a Startup Inhibit Period is initiated at  $t_0$ ,  $t_1$ , and  $t_2$ :

Before time  $t_0$ , when the input voltage is below 16V (typ.), the unit is disabled by the Input Under-Voltage Lockout feature. When the input voltage rises above 16V, the Input Under-Voltage Lockout is released, and a Startup Inhibit Period is initiated. At the end of this delay, the ON/OFF pin is evaluated, and since it is active, the unit turns on.

At time  $t_1$ , the unit is disabled by the ON/OFF pin, and it cannot be enabled again until the Startup Inhibit Period has elapsed.

When the ON/OFF pin goes high after  $t_2$ , the Startup Inhibit Period has elapsed, and the output turns on within the 4ms (typ.) "Turn On Time."

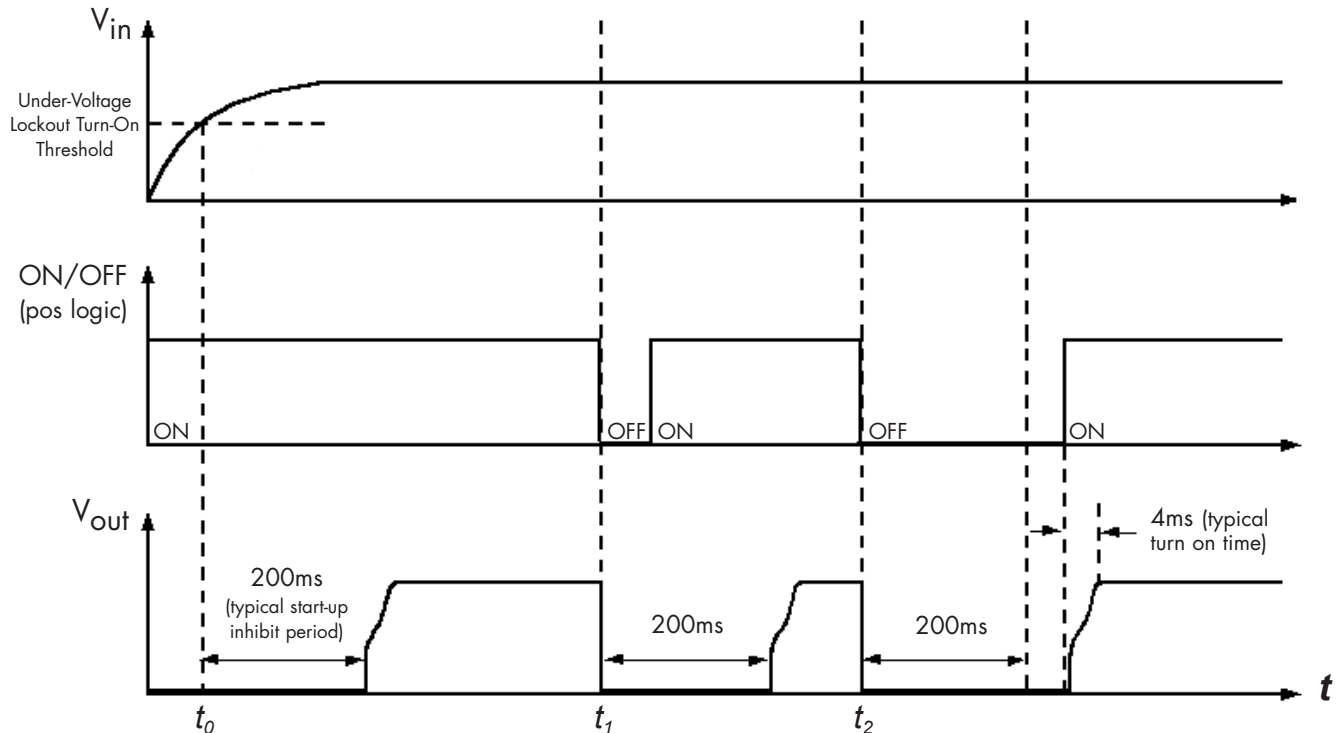

Figure F: Startup Inhibit Period (turn-on time not to scale)



## Standards and Qualifications

**Input:** 18 - 36V  
**Output:** 1.8V  
**Current:** 25A  
**Package:** Quarter-brick

Parameter	Notes & Conditions
-----------	--------------------

**STANDARDS COMPLIANCE**

CAN/CSA C22.2 No. 60950-1

UL 60950-1

EN 60950-1

Note: An external input fuse must always be used to meet these safety requirements. Contact SynQor for official safety certificates on new releases or download from the SynQor website.

Parameter	# Units	Test Conditions
-----------	---------	-----------------

**QUALIFICATION TESTING**

Life Test	32	95% rated Vin and load, units at derating point, 1000 hours
Vibration	5	10-55 Hz sweep, 0.060" total excursion, 1 min./sweep, 120 sweeps for 3 axis
Mechanical Shock	5	100 g minimum, 2 drops in x, y and z axis
Temperature Cycling	10	-40 °C to 100 °C, unit temp. ramp 15 °C/min., 500 cycles
Power/Thermal Cycling	5	Toperating = min to max, Vin = min to max, full load, 100 cycles
Design Marginality	5	Tmin-10 °C to Tmax+10 °C, 5 °C steps, Vin = min to max, 0-105% load
Humidity	5	85 °C, 95% RH, 1000 hours, continuous Vin applied except 5 min/day
Solderability	15 pins	MIL-STD-883, method 2003



## Ordering Information

**Input: 18 - 36V**  
**Output: 1.8V**  
**Current: 25A**  
**Package: Quarter-brick**

### PART NUMBERING SYSTEM

The part numbering system for SynQor's dc-dc converters follows the format shown in the example below.

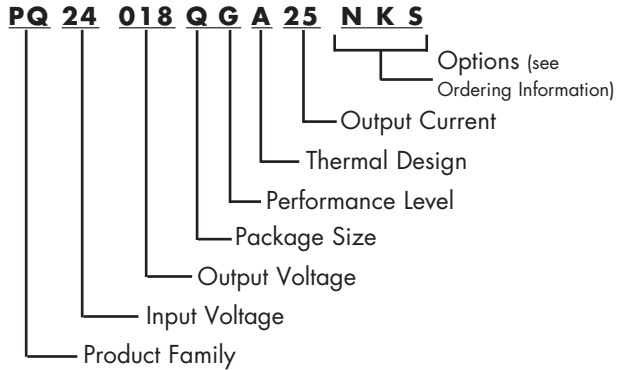

### Application Notes

A variety of application notes and technical white papers can be downloaded in pdf format from our website.

**RoHS Compliance:** The EU led RoHS (Restriction of Hazardous Substances) Directive bans the use of Lead, Cadmium, Hexavalent Chromium, Mercury, Polybrominated Biphenyls (PBB), and Polybrominated Diphenyl Ether (PBDE) in Electrical and Electronic Equipment. This SynQor product is 6/6 RoHS compliant. For more information please refer to SynQor's RoHS addendum available at our [RoHS Compliance / Lead Free Initiative web page](#) or e-mail us at [rohs@synqor.com](mailto:rohs@synqor.com).

### Contact SynQor for further information and to order:

**Phone:** 978-849-0600  
**Toll Free:** 888-567-9596  
**Fax:** 978-849-0602  
**E-mail:** [power@synqor.com](mailto:power@synqor.com)  
**Web:** [www.synqor.com](http://www.synqor.com)  
**Address:** 155 Swanson Road  
 Boxborough, MA 01719  
 USA

### ORDERING INFORMATION

The tables below show the valid model numbers and ordering options for converters in this product family. When ordering SynQor converters, please ensure that you use the complete 15 character part number consisting of the 12 character base part number and the additional characters for options. Add "-G" to the model number for 6/6 RoHS compliance.

The following options must be included in place of the **wxyz** spaces in the model numbers listed above.

Options Description: w x y z			
Thermal Design	Enable Logic	Pin Style	Feature Set
A - Open Frame B - Baseplated	N - Negative P - Positive	K - 0.110" N - 0.145" R - 0.180" Y - 0.250"	S - Standard

Not all combinations make valid part numbers, please contact SynQor for availability.

Model Number	Input Voltage Range	Output Voltage	Max Output Current
<a href="#">PQ24018QGw25xyz</a>	18 - 36V	1.8V	25A
<a href="#">PQ24033QGw25xyz</a>	18 - 36V	3.3 V	25A
<a href="#">PQ24050QGw20xyz</a>	18 - 36V	5.0 V	20A
<a href="#">PQ24120QGw08xyz</a>	18 - 36V	12 V	8.3A
<a href="#">PQ24150QGw07xyz</a>	18 - 36V	15 V	6.7A

### PATENTS

SynQor holds numerous U.S. patents, one or more of which apply to most of its power conversion products. Any that apply to the product(s) listed in this document are identified by markings on the product(s) or on internal components of the product(s) in accordance with U.S. patent laws. SynQor's patents include the following:

6,545,890    6,894,468    6,896,526    6,927,987    7,050,309    7,085,146  
 7,119,524    7,765,687    7,787,261    8,149,597    8,644,027

### WARRANTY

SynQor offers a three (3) year limited warranty. Complete warranty information is listed on our website or is available upon request from SynQor.